

# Circuitor

Multifunctional energy meter

**CEM-C21-T1, CEM-C21-T1-MID**  
**CEM-C21-485-T1, CEM-C21-485-T1-MID**  
**CEM-C21-485-DS, CEM-C21-485-DS-MID**



## INSTRUCTION MANUAL

(M016B01-03-20B)







## SAFETY PRECAUTIONS

Follow the warnings described in this manual with the symbols shown below.

	<p><b>DANGER</b> Warns of a risk, which could result in personal injury or material damage.</p>
---	---

	<p><b>ATTENTION</b> Indicates that special attention should be paid to a specific point.</p>
---	--

**If you must handle the unit for its installation, start-up or maintenance, the following should be taken into consideration:**

	<p>Incorrect handling or installation of the unit may result in injury to personnel as well as damage to the unit. In particular, handling with voltages applied may result in electric shock, which may cause death or serious injury to personnel. Defective installation or maintenance may also lead to the risk of fire. Read the manual carefully prior to connecting the unit. Follow all installation and maintenance instructions throughout the unit's working life. Pay special attention to the installation standards of the National Electrical Code.</p>
---	---

	<p><b>Refer to the instruction manual before using the unit</b> In this manual, if the instructions marked with this symbol are not respected or carried out correctly, it can result in injury or damage to the unit and /or installations.</p>
---	--

CIRCUTOR, SA reserves the right to modify features or the product manual without prior notification.

## DISCLAIMER

**CIRCUTOR, SA** reserves the right to make modifications to the device or the unit specifications set out in this instruction manual without prior notice.

**CIRCUTOR, SA** on its web site, supplies its customers with the latest versions of the device specifications and the most updated manuals.

[www.circutor.com](http://www.circutor.com)



	<p><b>CIRCUTOR</b>, recommends using the original cables and accessories that are supplied with the device.</p>
---	---

## CONTENTS

SAFETY PRECAUTIONS .....	3
DISCLAIMER .....	3
CONTENTS .....	4
REVISION LOG.....	5
SYMBOLS.....	5
1.- VERIFICATION UPON RECEPTION .....	6
2.- PRODUCT DESCRIPTION .....	6
3.- DEVICE INSTALLATION .....	7
3.1.- PRELIMINARY RECOMMENDATIONS .....	7
3.2.- INSTALLATION .....	8
3.3.- DEVICE TERMINALS.....	8
3.3.1. MODEL CEM-C21-T1 .....	8
3.3.2. MODEL CEM-C21-485-T1 .....	9
3.3.3. MODEL CEM-C21-485-DS .....	9
3.4.- CONNECTION DIAGRAM.....	10
3.5.- CONNECTIONS.....	11
4.- OPERATION .....	13
4.1.- BUTTON FUNCTIONS .....	13
4.2.- DISPLAY .....	13
4.3.- LED INDICATORS .....	14
4.4.- IMPULSE OUTPUT (CEM-C21-T1 and CEM-C21-485-T1 models) .....	15
4.5.- DIGITAL INPUT (CEM-C21-485-DS).....	15
5.- DISPLAY .....	16
5.1.- DISPLAY IN STANDBY MODE.....	16
5.2.- DISPLAY IN READING MODE .....	19
5.3.- INSTANTANEOUS VALUE DISPLAY.....	20
5.4.- PARTIAL ENERGY DISPLAY.....	22
5.5.- IMPULSE COUNT DISPLAY (CEM-C21-485-DS).....	25
5.6.- MANUFACTURER INFORMATION SCREEN.....	26
6.- CONFIGURATION .....	28
6.1.- Impulse output weight .....	28
6.2.- IMPULSE OUTPUT TYPE .....	29
6.3.- DIGITAL INPUT TYPE .....	29
6.4.- PERIPHERAL ADDRESS.....	30
6.5.- TRANSMISSION SPEED ( BAUD RATE) .....	31
6.6.- TYPE OF COMMUNICATIONS .....	31
6.7.- DISPLAY .....	32
6.7.1. PARTIAL ENERGY DISPLAY.....	32
6.7.2. REACTIVE ENERGY DISPLAY.....	33
6.7.3. EFFICIENCY FACTORS DISPLAY.....	33
6.8.- BACKLIGHT .....	34
6.9.- ENERGY COST .....	34
6.10.- CO <sub>2</sub> EMISSIONS.....	35
6.11.- PARTIAL ENERGY METER DELETION .....	36
6.12.- EXITING THE SETUP MENU .....	36
7.- COMMUNICATIONS.....	37
7.1.- INFRARED COMMUNICATIONS PORT (Model CEM-C21-T1) .....	37
7.2.- RS-485 COMMUNICATIONS PORT (Models CEM-C21-485-xx).....	37
7.2.1.- CONNECTION.....	37
7.2.2.- MODBUS PROTOCOL.....	38
7.2.3.- VARIABLES MODBUS.....	39
8.- TECHNICAL FEATURES .....	43
9.- MAINTENANCE AND TECHNICAL SERVICE.....	46
10.- GUARANTEE.....	46
11.- CE CERTIFICATE .....	47

**Note:** The images of the devices are solely for the purpose of illustration and may differ from the original device.





## REVISION LOG

Table 1: Revision log.

Date	Revision	Description
07/14	M016B01-03-14A	Initial Version
11/14	M016B01-03-14B	Changes in the following sections: 4.2. - 4.6
05/15	M016B01-03-15A	Changes in the following sections: 2 - 3.5 - 4.4.1. - 4.4.2. - 4.5. - 4.6. - 4.7. - 5
01/17	M016B01-03-17A	Changes in the following sections: 2 .- 5. - 8.
10/17	M016B01-03-17B	Changes in the following sections: 5.
07/18	M016B01-03-18A	Changes in the following sections: 2.- 3.3. - 4.7.3. - 4.7.4. - 4.7.5. - 4.8.- 4.11. - 5.
09/18	M016B01-03-18B	Changes in the following sections: 3.5.
10/19	M016B01-03-19A	Changes in the following sections: 2. - 3.3. - 3.5. - 4.2. - 4.5. - 5.1. - 5.2. - 5.3. - 5.4. - 5.5. - 5.6. - 6.2. - 7.2.2.2. - 7.2.3. - 8.
01/20	M016B01-03-20A	Changes in the following sections: 3.2.- 3.5
05/20	M016B01-03-20B	Changes in the following sections: 8.

## SYMBOLS

Table 2: Symbols.

Symbol	Description
	Compliant with the relevant European standards.
	Device covered by European directive 2012/19/EC. At the end of its useful life, do not leave the unit in a household waste container. Follow local regulations on electronic equipment recycling.
	DC current
	AC current

## 1.- VERIFICATION UPON RECEPTION

Check the following points upon receiving the device:

- a) The device meets the specifications described in your order.
- b) The device has not suffered any damage during transport.
- c) Perform an external visual inspection of the device prior to switching it on.
- d) Check that it has been delivered with the following:
  - An installation guide.
  - Safety label (terminal cover).



If any problem is noticed upon reception, immediately contact the transport company and/or **CIRCUTOR's** after-sales service.

## 2.- PRODUCT DESCRIPTION

The **CEM-C21** static three-phase energy meter measures class B active energy (EN50470) / class 1(IEC 62053-21) and (optional) class 2 reactive energy (IEC 62053-23).



The device features:

- **1 button** that allows you to browse the different screens and program the device.
- **2 Verification LEDs**.
- **LCD display**, displays all parameters,
- **2 connection seals**,
- **2 terminal covers**, to cover the top of the terminal box and the fixing screws.
- **RS-485 communications (CEM-C21-485-xx models)**.
- **Optical communications port** for communications with other modules installed on a DIN rail with a service port (**CEM-C21-T1** model).
- **Impulse output** (models **CEM-C21-T1** and **CEM-C21-485-T1**).
- **Digital input** (model **CEM-C21-485-DS**).

### 3.- DEVICE INSTALLATION

#### 3.1.- PRELIMINARY RECOMMENDATIONS



In order to use the device safely, it is critical that individuals who handle it follow the safety measures set out in the standards of the country where it is being used, use the necessary personal protective equipment, and pay attention to the various warnings indicated in this instruction manual.

The **CEM-C21** device must be installed by authorised and qualified staff.

The power supply plug must be disconnected and measuring systems switched off before handling, altering the connections or replacing the device. It is dangerous to handle the device while it is powered.

Also, it is critical to keep the cables in perfect condition in order to avoid accidents, personal injury and damage to installations.

The manufacturer of the device is not responsible for any damage resulting from failure by the user or installer to observe the warnings and/or recommendations set out in this manual, nor for damage resulting from the use of non-original products or accessories or those made by other manufacturers.

If an anomaly or malfunction is detected in the device, do not use the device to take any measurements.

Inspect the work area before taking any measurements. Do not take measurements in dangerous areas or where there is a risk of explosion.



Disconnect the device from the power supply (device and measuring system power supply) before maintaining, repairing or handling the device's connections.  
Please contact the after-sales service if you suspect that there is an operational fault in the device.

3.2.- INSTALLATION

On the side of the device are all of the indications adjusted to the CEI 62052-11 standard.

The device is installed on a DIN rail. All electrical connections must be covered by the plastic covers, and only the display and keypad should remain exposed.

	<p>Terminals, opening covers or removing elements can expose parts that are hazardous to the touch while the device is powered. Do not use the device until it is fully installed.</p>
---	--

3.3.- DEVICE TERMINALS

3.3.1. MODEL CEM-C21-T1

Table 3:List of CEM-C21-T1 terminals.

Device terminals	
1 : L1, Current input (voltage) L1	10: N, Neutral input
3: L1, Current output (voltage) L1	12: N, Neutral output
4: L2, Current input (voltage) L2	13: Auxiliary Power Supply
6: L2, Current output (voltage) L2	14: Auxiliary Power Supply
7: L3, Current input (voltage) L3	21: impulse output (Collector)
9: L3, Current output (voltage) L3	22: Impulse output (Emitter)

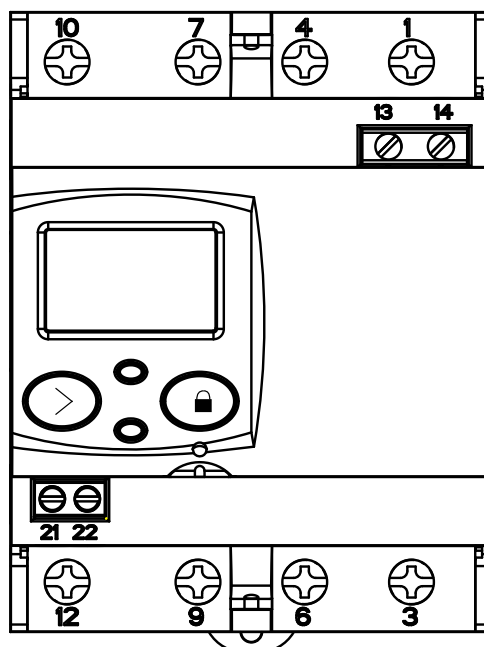

Figure 1:Terminals of the CEM-C21-T1.



## 3.3.2. MODEL CEM-C21-485-T1

Table 4:List of CEM-C21-485-T1 terminals.

Device terminals	
1 : L1, Current input (voltage) L1	12: N, Neutral output
3: L1, Current output (voltage) L1	13: Auxiliary Power Supply
4: L2, Current input (voltage) L2	14: Auxiliary Power Supply
6: L2, Current output (voltage) L2	21: impulse output (Collector)
7: L3, Current input (voltage) L3	22: Impulse output (Emitter)
9: L3, Current output (voltage) L3	23: B(-), RS-485
10: N, Neutral input	24: A(+), RS-485

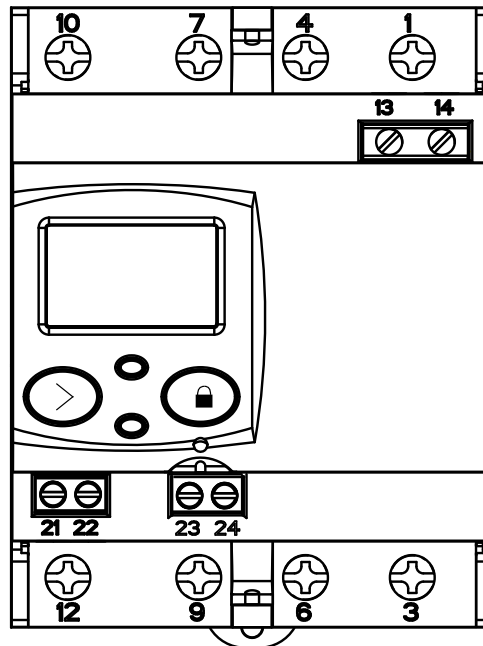

Figure 2:Terminals of the CEM-C21-485-T1 and CEM-C21-485-DS.

## 3.3.3. MODEL CEM-C21-485-DS

Table 5:List of CEM-C21-485-DS terminals.

Device terminals	
1 : L1, Current input (voltage) L1	12: N, Neutral output
3: L1, Current output (voltage) L1	13: Auxiliary Power Supply
4: L2, Current input (voltage) L2	14: Auxiliary Power Supply
6: L2, Current output (voltage) L2	21: Digital input
7: L3, Current input (voltage) L3	22: Digital input (common)
9: L3, Current output (voltage) L3	23: B(-), RS-485
10: N, Neutral input	24: A(+), RS-485

3.4.- CONNECTION DIAGRAM

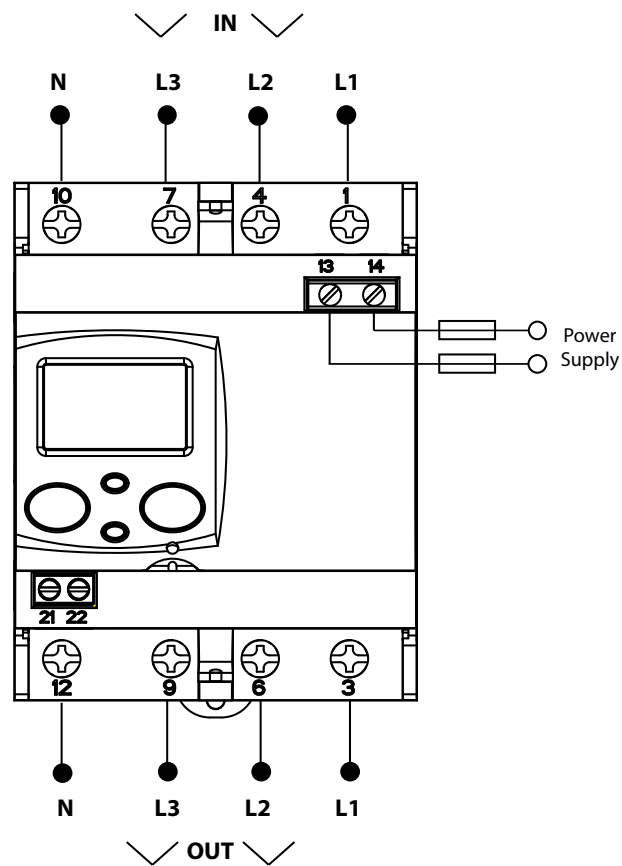

Figure 3: Connection diagram, CEM-C21.

## 3.5.- CONNECTIONS

The **CEM-C21** has terminal covers to cover the top of the terminal box and the fixing screws (Figure 4).

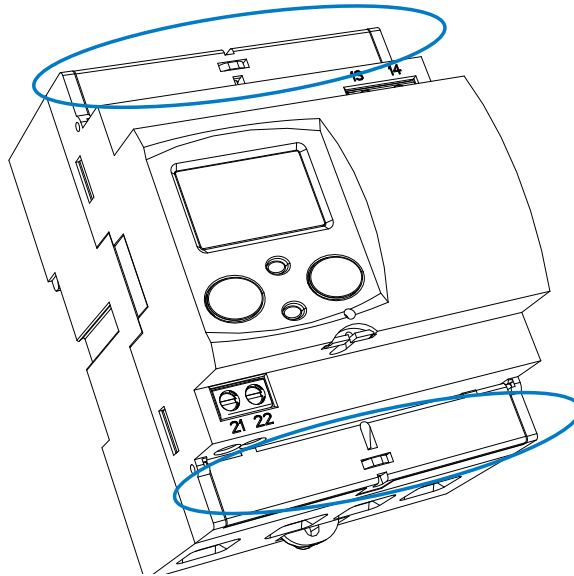

Figure 4: Terminal covers of the CEM-C21.

The fixing screws are of the mixed type, allowing the use of PZ2 and flat head screwdrivers.

Table 6:CEM-C21 connections.

Connections	
<b>Measurement terminals (1, 3, 4, 6, 7, 9, 10, 12)</b>	
<b>Maximum cable cross-section</b>	25 mm <sup>2</sup> ( 16 mm <sup>2</sup> with end sleeve ) ≤ 1.7 Nm
<b>Screwdrivers head</b>	flat head (1.2 x 6.0 mm) or PH2
<b>Impulse output terminals / Digital input (21, 22), Power supply (13, 14) and RS-485 (23, 24)</b>	
<b>Maximum cable cross-section</b>	1.5 mm <sup>2</sup> ( 1.5 mm <sup>2</sup> with end sleeve ) ≤ 0.6 Nm
<b>Screwdrivers head</b>	flat head (3 x 0.5 mm)

Once connected, the device can be protected with two connection seals (Figure 5).

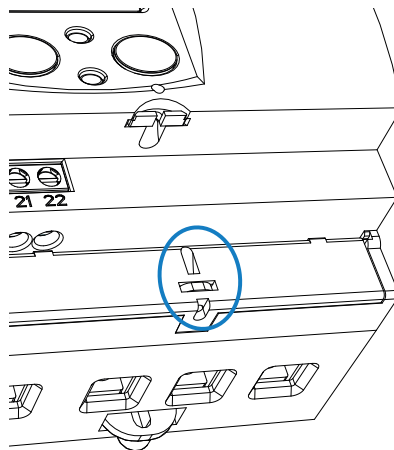

Figure 5: Seal of the CEM-C21.



Once the device is powered, attach the safety label (**Figure 6**) to terminals 13 and 14 to seal the device.

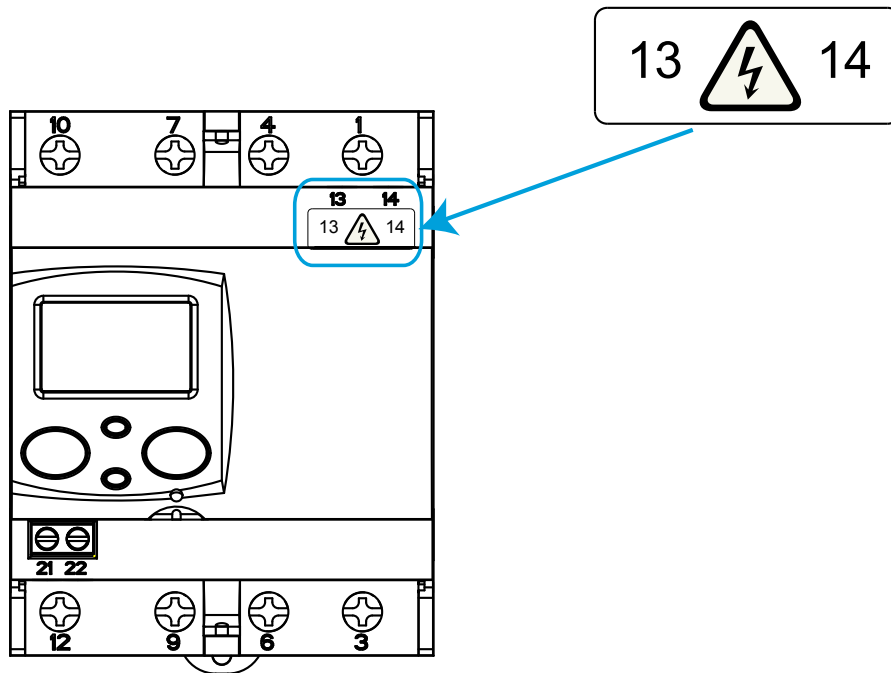

Figure 6: Attaching the safety label.

## 4.- OPERATION

The **CEM-C21** is an energy meter capable of measuring:



- ✓ Imported and exported active energy and reactive energy in the four quadrants. (according to version).
- ✓ Active, reactive and apparent power (according to version).
- ✓ RMS voltage and current.
- ✓ Power factor, PF

### 4.1.- BUTTON FUNCTIONS

The **CEM-C21** has 1 button that allows you to browse the different screens and configure the device.

Button functions on the measuring screens (**Table 7**):

Table 7: Button functions on the measuring screens.

Button	Short press	Long press (> 2 s)
	For the cyclic movement. Next screen.	Enters reading mode.
	No function.	

### 4.2.- DISPLAY

The device has an LCD where all parameters are displayed.

The display is divided into three areas (**Figure 7**):

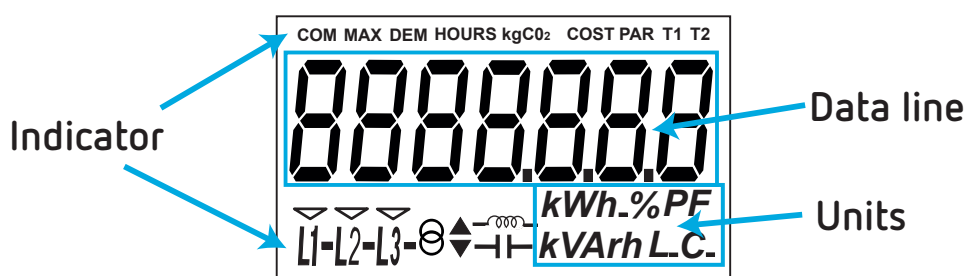

Figure 7: CEM-C21 Display areas

- ✓ **Data line**, displaying the values measured by the device.
- ✓ **Units**, where the unit of the magnitude being viewed is shown.
- ✓ **Indicators**, which shows other parameters:

**COM**, indicates that there is a communications module connected. It flashes when the communications are established.

**HOURS**, displays the time in hours.

**kgCO<sub>2</sub>**, displays the quantity of kgCO<sub>2</sub> released into the atmosphere according to the energy consumed.

**COST**, indicates that the variable displayed in the data line is a cost.

**PAR**, indicates that the variable displayed in the data line is a partial meter.

**T1** and **T2**, indicate the tariff corresponding to the on-screen information.

**L1 - L2 - L3** - Indicates the presence of voltage in each phase, with its corresponding current direction:

“ - “ is used to show the power yielded to the network.

“ “ is used to show the power absorbed by the network.

⊖ ▼ Indicates that the energy being viewed is generated.

⊖ ▲ Indicates that the energy being viewed is consumed.

— ∞ — Indicates that the energy is inductive.

— ⊥ — Indicates that the energy is capacitive.

#### 4.3.- LED INDICATORS

The device has two verification LEDs:

- ✓ To verify the **active energy**.
- ✓ To verify the **reactive energy** (according to version).

The weight of the LEDs is 4,000 imp/kWh (kvarh).

The LEDs will remain lit when the current is lower than the energy meter start-up current. Once the start-up current is exceeded (due to active or reactive power consumption) the LEDs are turned off and emit impulses that are proportional to the measured energy.

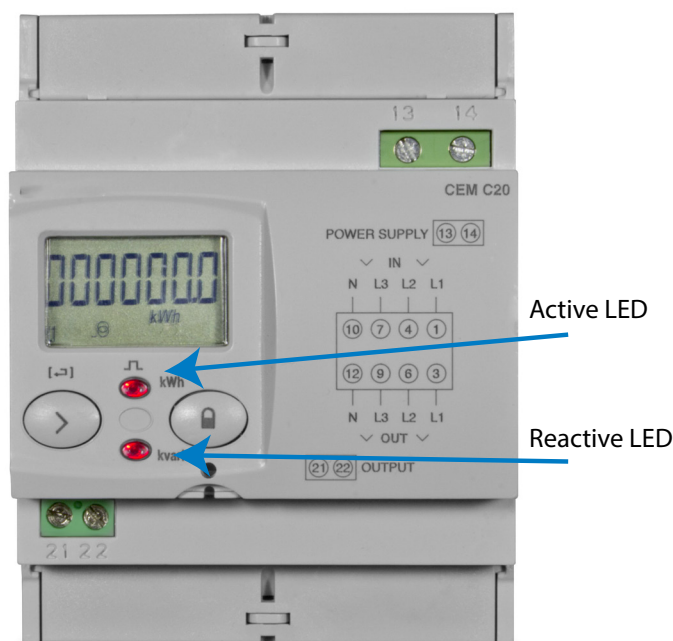

Figure 8: LED Indicators of the CEM-C21.

#### 4.4.- IMPULSE OUTPUT (CEM-C21-T1 and CEM-C21-485-T1 models)

The energy meter has optocoupler type outputs capable of generating impulses at a previously programmed rate. (See "6.1. IMPULSE OUTPUT WEIGHT" and "6.2. IMPULSE OUTPUT TYPE" )

#### 4.5.- DIGITAL INPUT (CEM-C21-485-DS)

The **CEM-C21-485-DS** model features a impulse input (terminals 21 and 22 in **Table 5**) to calculate other supplies or select tariffs.

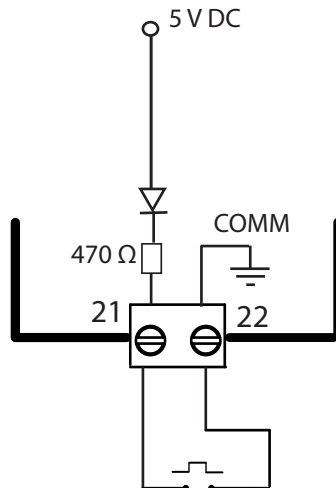

Figure 9: Digital input, CEM-C21-485-DS.

Active Tariff selection:

Table 8: Tariff selection.

Tariff	Tariff selection
Tariff 1	
Tariff 2	

5.- DISPLAY

The **CEM-C21** has 2 display modes:

- ✓ Display in standby mode
- ✓ Display in reading mode

5.1.- DISPLAY IN STANDBY MODE

With the display in standby mode, all of the information is presented in cyclic form without any need to perform any action on the **CEM-C21** buttons.

This mode displays different parameters, see **Table 9** and **Table 10**, that alternate every 6 seconds.

The device is in this mode by default when none of the buttons are pressed.

Short press the  button to stop the cyclic movement of the parameter being shown at the time.

From then on, short press the  button to browse all the parameters defined in **Table 9** and **Table 10**.

Table 9: Standby mode displays (Table 1)





Models CEM-C21-T1, CEM-C21-485-T1, CEM-C21-485-DS (Impulse count option <sup>(1)</sup> )	
Screen	Parameters
	Total imported active energy
	Total exported active energy <i>Only displayed in the 4-quadrant version.</i>
	Reactive energy quadrant L+ total <sup>(2)</sup>
	Reactive energy quadrant L- total <sup>(2)</sup> <i>Only displayed in the 4-quadrant version.</i>
	Reactive energy quadrant C- total <sup>(2)</sup> <i>Only displayed in the 4-quadrant version.</i>

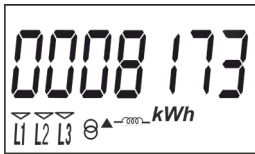
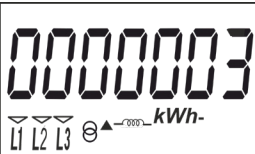
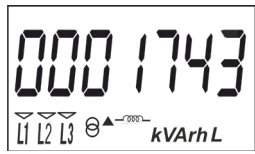

Table 9 (Continuation): Standby mode displays (Table 1)

Screen	Parameters
	Reactive energy quadrant C+ total <sup>(2)</sup>

<sup>(1)</sup> The impulse count option for the **CEM-C21-485-DS** model can be configured in section “6.3.-DIGITAL INPUT TYPE”

<sup>(2)</sup> Only displayed if the reactive energy display option has been selected in the setup menu ( see “6.7.2. REACTIVE ENERGY DISPLAY”).

Table 10: Standby mode displays (Table 2).







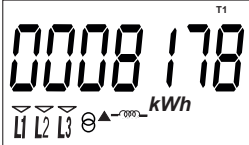
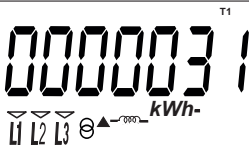

Model CEM-C21-485-DS (Tariff option <sup>(3)</sup> )	
Screen	Parameters
	Imported active energy Tariff 1
	Exported active energy Tariff 1 <i>Only displayed in the 4-quadrant version.</i>
	Reactive energy quadrant L+ Tariff 1 <sup>(4)</sup>
	Reactive energy quadrant L- Tariff 1 <sup>(4)</sup> <i>Only displayed in the 4-quadrant version.</i>
	Reactive energy quadrant C- Tariff 1 <sup>(4)</sup> <i>Only displayed in the 4-quadrant version.</i>
	Reactive energy quadrant C+ Tariff 1 <sup>(4)</sup>
	Imported active energy Tariff 2
	Exported active energy Tariff 2 <i>Only displayed in the 4-quadrant version.</i>

Table 10 (Continuation) : Standby mode displays (Table 2).

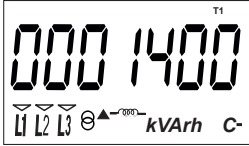
Screen	Parameters
	Reactive energy quadrant L+ Tariff 2 <sup>(4)</sup>
	Reactive energy quadrant L- Tariff 2 <sup>(4)</sup> <i>Only displayed in the 4-quadrant version.</i>
	Reactive energy quadrant C- Tariff 2 <sup>(4)</sup> <i>Only displayed in the 4-quadrant version.</i>
	Reactive energy quadrant C+ Tariff 2 <sup>(4)</sup>

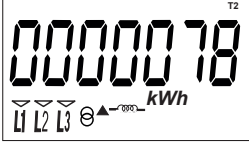
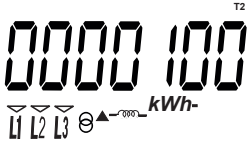
<sup>(3)</sup> The impulse count option for the **CEM-C21-485-DS** model can be configured in section “**6.3.- DIGITAL INPUT TYPE**”

<sup>(4)</sup> Only displayed if the reactive energy display option has been selected in the setup menu ( see “**6.7.2. REACTIVE ENERGY DISPLAY**”).

When the active Tariff does not match the Tariff being displayed, a flashing active Tariff indicator is displayed.

The standby mode is activated again when no button is pressed for 60 seconds.

## 5.2.- DISPLAY IN READING MODE

The reading mode is activated by a long press on the  button.  
In reading mode you can:

- ✓ View the voltage, current, active power, apparent power and power factor of the installation.
- ✓ View the energies of the partial energy meters.
- ✓ Impulse count display (**CEM-C21-485-DS** model)
- ✓ Enter the setup menu.
- ✓ View the manufacturer information.

The navigation diagram is shown in **Figure 10**:

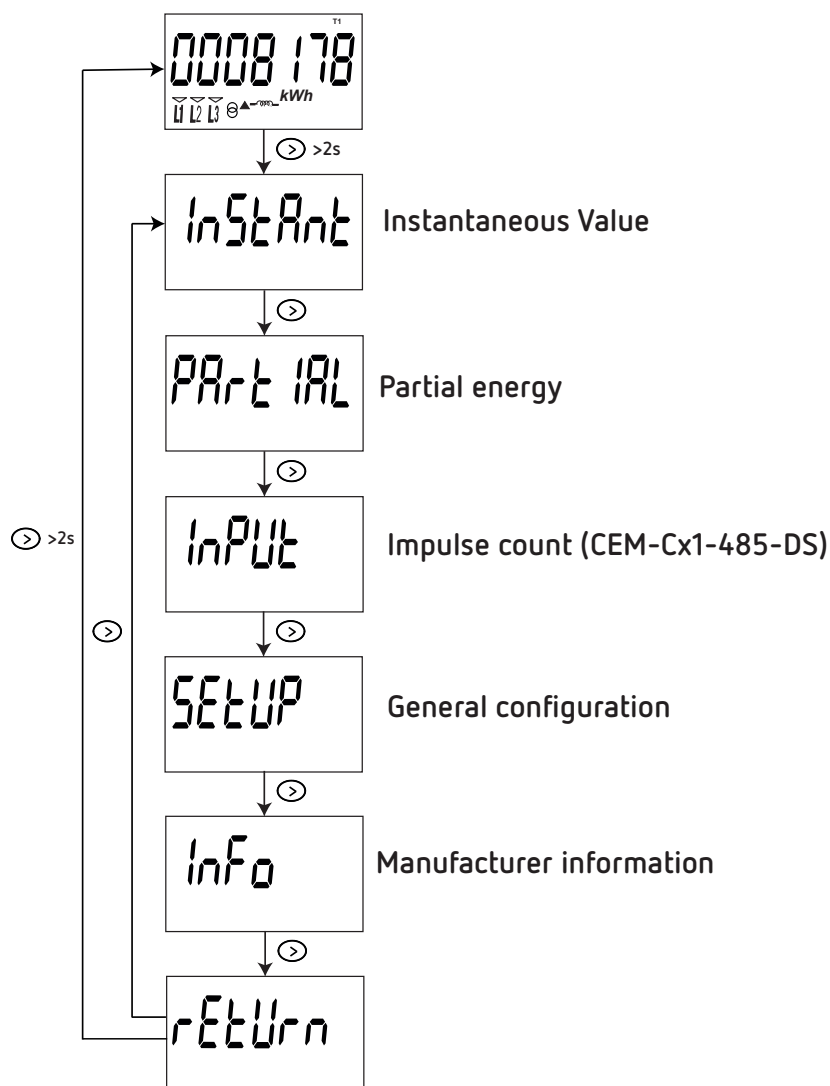

Figure 10: Navigation diagram in reading mode of the CEM-C21.

5.3.- INSTANTANEOUS VALUE DISPLAY



To open the screens where the instantaneous value are viewed, long press the  key on the display in standby mode. The home screen is displayed **Figure 11** :



Figure 11: Instantaneous Value main screen.

Long press the  button to open the different screens.

Short press the button to browse the different screens (see **Table 11**).

Long press the  button to exit the instantaneous values screens.

The standby mode is activated again when no button is pressed for 60 seconds.

Table 11: Instantaneous value screens.



Screen	Parameters
	L1 Voltage
	L2 Voltage
	L3 Voltage
	L1 Current
	L2 Current
	L3 Current

Table 11 (Continuation): Instantaneous value screens.

Screen	Parameters
	Active three-phase power
	Reactive three-phase power <sup>(5)</sup>
	Apparent three-phase power
	L1 Power Factor
	L2 Power Factor
	L3 Power Factor
	CEM-C21-T1, CEM-C21-485-T1, CEM-C21-485-DS models <sup>(6)</sup> : Hours of operation from manufacture
	CEM-C21-485-DS model <sup>(7)</sup> : Tariff 1 operating hours, from manufacture
	CEM-C21-485-DS model <sup>(7)</sup> : Tariff 2 operating hours, from manufacture

<sup>(5)</sup> The device must be connected to the L1 phase to calculate the reactive power.

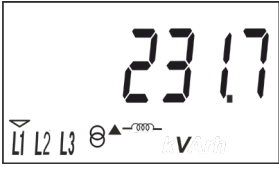
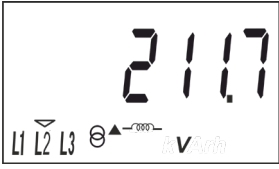
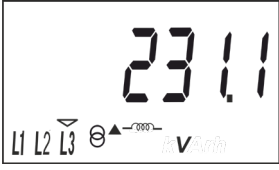
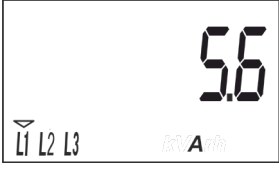
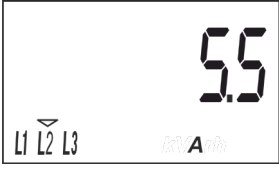
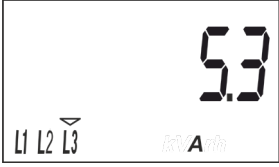
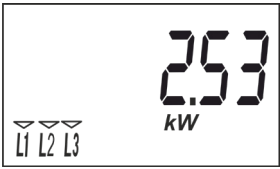
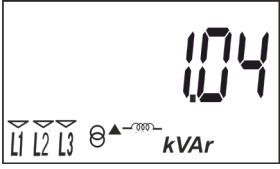
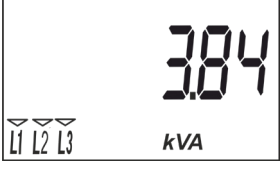
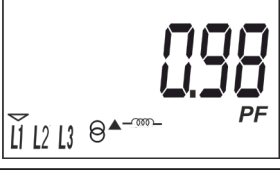
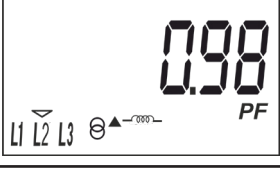
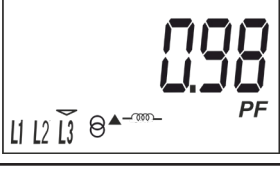
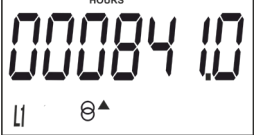
<sup>(6)</sup> Visible display for the **CEM-C21-485-DS** model with impulse count option, see “6.3.- **DIGITAL INPUT TYPE**”

<sup>(7)</sup> Visible display for the **CEM-C21-485-DS** model with tariff option, see “6.3.- **DIGITAL INPUT TYPE**”

5.4.- PARTIAL ENERGY DISPLAY

**Note:** The partial energy display menu is only displayed if the partial energy display option has been selected in the setup menu (see “ 6.7.1. PARTIAL ENERGY DISPLAY” )



Long press the  key in the standby mode screen to open these display screens. Short press the key to display the partial energy main screen, **Figure 12**.



Figure 12: Partial energy main screen.

Long press the  button to open the different screens. Short press the button to browse the different screens (see **Table 12** and **Table 13**).

The **PAR** icon on the display indicates that you are viewing the partial energies.

Long press the  button to exit the Partial energy screens.

The standby mode is activated again when no button is pressed for 60 seconds.

Table 12:Partial energy screens (Table 1).





Models CEM-C21-T1, CEM-C21-485-T1, CEM-C21-485-DS (Impulse count option <sup>(8)</sup> )	
Screen	Parameters
	Partial imported active energy
	Partial exported active energy <i>Only displayed in the 4-quadrant version.</i>
	Partial reactive energy, quadrant 1 (L+) <sup>(9)</sup>
	Partial reactive energy, quadrant 2 (L-) <sup>(9)</sup> <i>Only displayed in the 4-quadrant version.</i>

Table 12 (Continuation) : Partial energy screens (Table 1).

Screen	Parameters
	Partial reactive energy, quadrant 3 ( C- ) <sup>(9)</sup> <i>Only displayed in the 4-quadrant version.</i>
	Partial reactive energy, quadrant 4 ( C+ ) <sup>(9)</sup>
	Hours in partial operation (since the last partial reset )
	Cost of the partial active energy consumed (since the last partial reset ) <sup>(10)</sup>
	CO <sub>2</sub> emissions into the atmosphere. (since the last partial reset ) <sup>(10)</sup>

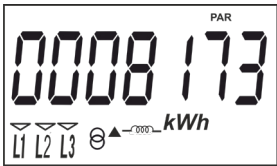
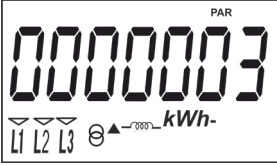
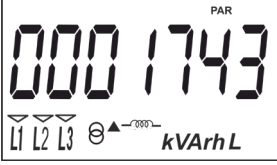
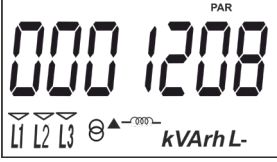
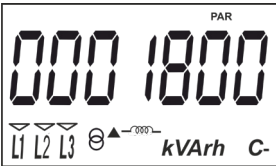
<sup>(8)</sup> The impulse count option for the **CEM-C21-485-DS** model can be configured in section “**6.3.-DIGITAL INPUT TYPE**”

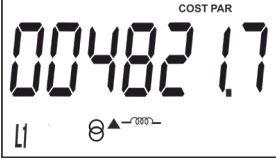
<sup>(9)</sup> Only displayed if the reactive energy display option has been selected in the setup menu (see “**6.7.2. REACTIVE ENERGY DISPLAY**”).

<sup>(10)</sup> Only displayed if the efficiency factors display option has been selected in the setup menu (see “**6.7.3. EFFICIENCY FACTORS DISPLAY**”).

Table 13: Partial energy screens (Table 2).



Model CEM-C21-485-DS (Tariff option <sup>(11)</sup> )	
Screen	Parameters
	Partial imported active energy Tariff 1
	Partial exported active energy Tariff 1 <i>Only displayed in the 4-quadrant version.</i>
	Partial reactive energy, quadrant 1(L+) Tariff 1. <sup>(12)</sup>

Tabla 13 (Continuation) : Partial energy screens (Table 2).





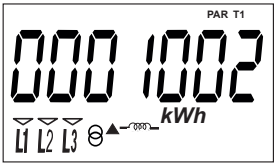
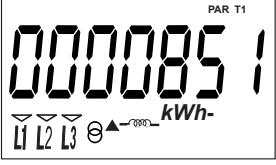

Screen	Parameters
	Partial reactive energy, quadrant 2 (L-) Tariff 1. <sup>(12)</sup> <i>Only displayed in the 4-quadrant version.</i>
	Partial reactive energy, quadrant 3 (C-) Tariff 1. <sup>(12)</sup> <i>Only displayed in the 4-quadrant version.</i>
	Partial reactive energy, quadrant 4 (C+) Tariff 1. <sup>(12)</sup>
	Partial imported active energy Tariff 2
	Partial exported active energy Tariff 2 <i>Only displayed in the 4-quadrant version.</i>
	Partial reactive energy, quadrant 1 (L+) Tariff 2. <sup>(12)</sup>
	Partial reactive energy, quadrant 2 (L-) Tariff 2. <sup>(12)</sup> <i>Only displayed in the 4-quadrant version.</i>
	Partial reactive energy, quadrant 3 (C-) Tariff 2. <sup>(12)</sup> <i>Only displayed in the 4-quadrant version.</i>
	Partial reactive energy, quadrant4 (C+) Tariff 2. <sup>(12)</sup>
	Hours in partial operation Tariff 1. (since the last partial reset )

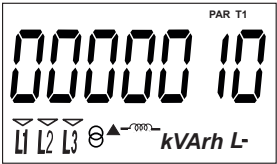
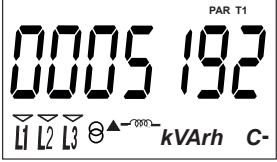
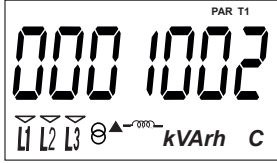
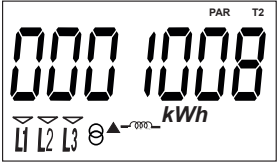
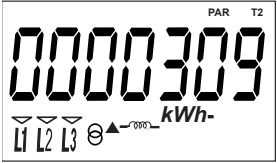
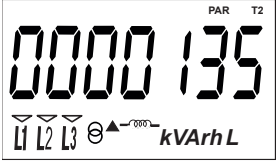
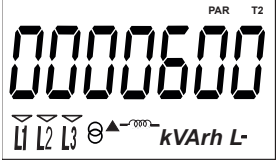
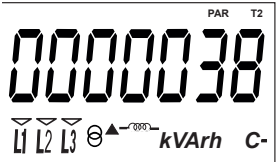
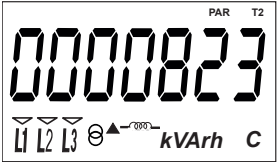

Tabla 13 (Continuation) : Partial energy screens (Table 2).

Screen	Parameters
	Cost of the partial active energy consumed Tariff 1 (since the last partial reset ) <sup>(13)</sup>
	CO <sub>2</sub> emissions into the atmosphere Tariff 1 (since the last partial reset ) <sup>(13)</sup>
	Hours in partial operation Tariff 2. (since the last partial reset )
	Cost of the partial active energy consumed Tariff 2 (since the last partial reset ) <sup>(13)</sup>
	CO <sub>2</sub> emissions into the atmosphere Tariff 2 (since the last partial reset ) <sup>(13)</sup>

<sup>(11)</sup> The tariff option for the **CEM-C21-485-DS** model can be configured in section “**6.3.- DIGITAL INPUT TYPE**”

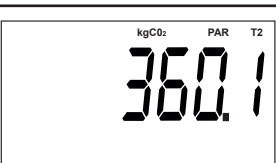
<sup>(12)</sup> Only displayed if the reactive energy display option has been selected in the setup menu ( see “**6.7.2. REACTIVE ENERGY DISPLAY**”).

<sup>(13)</sup> Only displayed if the efficiency factors display option has been selected in the setup menu ( see “**6.7.3. EFFICIENCY FACTORS DISPLAY**”).

### 5.5.- IMPULSE COUNT DISPLAY (CEM-C21-485-DS)

**Note:** The impulse count display screens are only visible if the impulse count option has been configured in the **CEM-C21-485-DS** model.

To access the pulse count screens, press the  key for a prolonged time on the screen in standby mode. Short presses will display the initial impulse count screen, **Figure 13**:

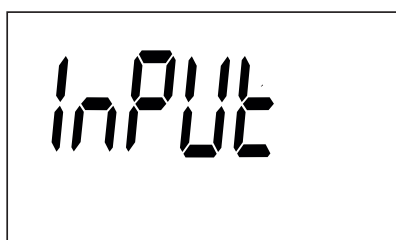

Figure 13: Main impulse count screen.

To access the different screens, press key  for a prolonged time.

Short press the button to browse the different screens (Table 14).

To exit the impulse count screens, press key  for a prolonged time.

The standby mode is activated again when no button is pressed for 60 seconds.

Table 14: Impulse count screens.

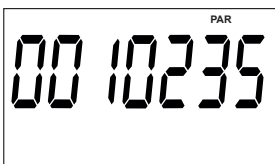
Screen	Parameters
	Total impulse count
	Partial impulse count <sup>(14)</sup>

<sup>(14)</sup> Only visible if the partial energy display has been selected in the setup menu (see “6.7.1.PARTIAL ENERGY DISPLAY”).

## 5.6.- MANUFACTURER INFORMATION SCREEN

Long press the  button in the standby mode screen to open these display screens. Short press the button to display the manufacturer information home screen, Figure 14:



Figure 14: Manufacturer information home screen.

Long press the  button to open the different screens.

Short press the button to browse the different screens (see Table 15).

Long press the  button to exit the instantaneous values screens.

The standby mode is activated again when no button is pressed for 60 seconds.

Table 15: Manufacturer information screens.





Screen	Parameters
	Device model

Table 15 (Continuation): Manufacturer information screens.

Screen	Parameters
	Version
	Communications protocol <sup>(15)</sup>
	Communications protocol version <sup>(15)</sup>
	Active energy with resolution in Wh
	Reactive energy with resolution varh
	32-bit CRC

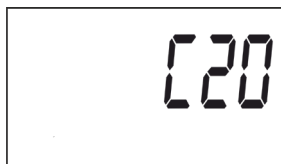
<sup>(15)</sup> The screen is displayed if it is a **CEM-C21-T1** and there is a **CEM M-RS485** (communications interface for the CEM family of devices) connected to the device.

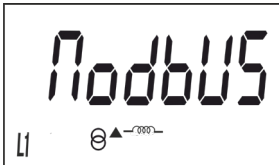
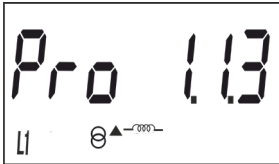
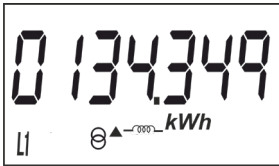
## 6.- CONFIGURATION

Long press the  button in the standby mode screen to open these setup screens. Short press the button to display the home screen, **Figure 15**:



Figure 15: Programming home screen

In the setup menu you can:

- ✓ Program the weight and type of impulse output
- ✓ Program the digital input operating mode.
- ✓ Program the communications.
- ✓ Program the display screen.
- ✓ Program the cost of the energy and the CO<sub>2</sub> emissions
- ✓ Delete the partial energy meters.

The standby mode is activated again when no button is pressed for 60 seconds.

Long press the  button to access the first programming step.

### 6.1.- IMPULSE OUTPUT WEIGHT

**Note:** Screen only visible for **CEM-C21-T1** and **CEM-C21-485-T1** models.

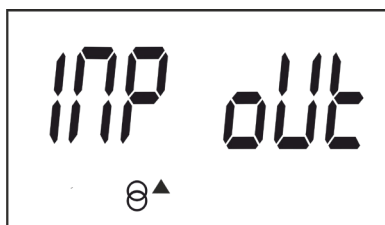

This is the home screen for entering the weight of the impulse output.

Long press the button to view the value to be programmed.

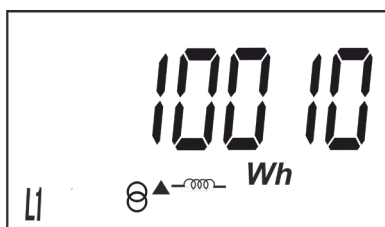

To write or modify the value, short press the  button repeatedly, increasing the value of the flashing digit.

When the desired value is shown on the screen, move onto the next digit with a long press on the  button, allowing the remaining values to be modified.

To validate the data, move to the last digit and long press the  button; the validation screen will appear (**Figure 16**) indicating that the programming value has been saved.



Figure 16: Validation screen.

After a few seconds viewing the screen shown on **Figure 16**, the system returns to the **Impulse output weight** programming main screen.

**Minimum value:** 99999.

**Maximum value:** 0.

Short press the  button to access the next programming step.

## 6.2.- IMPULSE OUTPUT TYPE

**Note:** Screen only visible for **CEM-C21-T1** and **CEM-C21-485-T1** models.

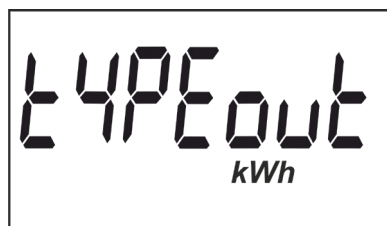

The impulse output type is selected on this screen, between: **kWh** or **KVArh**.

Short press the  button to browse the different options.

To validate the data, long press the  button and the validation screen will appear (**Figure 16**) indicating that the programming value has been saved.

After a few seconds viewing the screen shown on **Figure 17**, the system returns to the **Impulse output type** programming main screen.

Short press the  button to access the next programming step.

## 6.3.- DIGITAL INPUT TYPE

**Note:** Screen only visible for the **CEM-C21-485-DS** model.



The digital input operation is selected from this screen: **Count** (as impulse counter) or **tariff** (Tariff Operation).

Short press the  button to browse the different options.

To validate the data, long press the  button and the validation screen will appear

(Figure 16) indicating that the programming value has been saved.

After a few seconds displaying the screen in Figure 16, it returns to the main digital input Type programming screen.

Short press the  button to access the next programming step.

#### 6.4.- PERIPHERAL ADDRESS

**Note:** This is only displayed if it is a **CEM-C21-485-T1** or **CEM-C21-485-DS** or if there is a **CEM M-RS485** (communications interface for the **CEM** family of devices) connected to the **CEM-C21-T1** model.



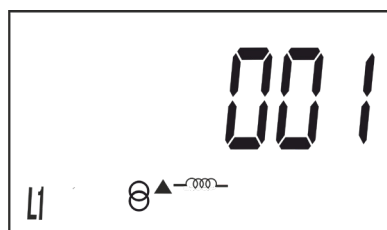

This is the home screen for entering the peripheral address.

Long press the button to view the value to be programmed.



To write or modify the value, short press the  button repeatedly, increasing the value of the flashing digit.

When the desired value is shown on the screen, move onto the next digit with a long press on the  button, allowing the remaining values to be modified.

To validate the data, move to the last digit and long press the  button; the validation screen will appear (Figure 16) indicating that the programming value has been saved.

After a few seconds viewing the screen shown on Figure 16, the system returns to the **Peripheral address** programming main screen.

**Minimum value:** 1.

**Maximum value:** 254

Short press the  button to access the next programming step.

## 6.5.- TRANSMISSION SPEED ( BAUD RATE)

**Note:** This is only displayed if it is a **CEM-C21-485-T1** or **CEM-C21-485-DS** or if there is a **CEM M-RS485** (communications interface for the **CEM** family of devices) connected to the **CEM-C21-T1** model.

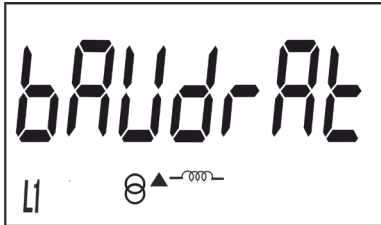



This is the home screen for entering the transmission speed.

Long press the button to view the value to be programmed.



The transmission speed (Baud rate) is selected on this screen, and may be: **9600**, **19200** or **38400**.

Short press the  button to browse the different options.

To validate the data, long press the  button and the validation screen will appear (**Figure 16**) indicating that the programming value has been saved.

After a few seconds viewing the screen shown on **Figure 16**, the system returns to the **Transmission speed** programming main screen.

Short press the  button to access the next programming step.

## 6.6.- TYPE OF COMMUNICATIONS

**Note:** This is only displayed if it is a **CEM-C21-485-T1** or **CEM-C21-485-DS** or if there is a **CEM M-RS485** (communications interface for the **CEM** family of devices) connected to the **CEM-C21-T1** model.

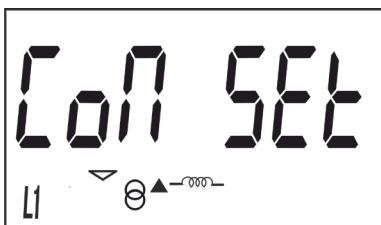

This is the home screen for selecting the number of bits, the parity and the number of stop bits of the communications frame.

Long press the button to view the value to be programmed.

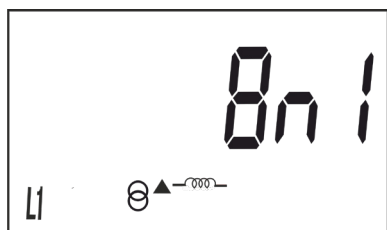

This screen shows the different options:

- Bn1* : 8 bits, no parity, 1 stop bit.
- BE1* : 8 bits, even parity, 1 stop bit.
- Bo1* : 8 bits, odd parity, 1 stop bit.
- Bn2* : 8 bits, no parity, 2 stop bits.
- BE2* : 8 bits, even parity, 2 stop bits.
- Bo2* : 8 bits, odd parity, 2 stop bits.

Short press the  button to browse the different options.

To validate the data, long press the  button and the validation screen will appear (**Figure 16**) indicating that the programming value has been saved.

After a few seconds viewing the screen shown on **Figure 16**, the system returns to the **Communications type** programming main screen.

Short press the  button to access the next programming step.

## 6.7.- DISPLAY



This is the home screen for selecting the unit display options.

Long press to access the partial energy display selection screen:

### 6.7.1. PARTIAL ENERGY DISPLAY

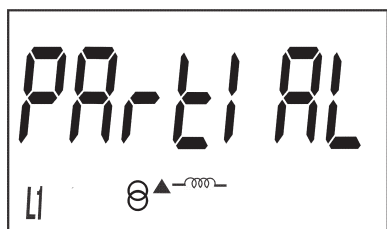

This is the home screen for selecting the partial energy display view option.

Long press to view the options.

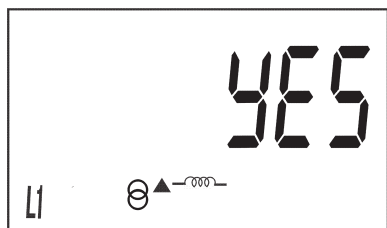

The possible options are:

**Yes**, if you want to view the partial energy.

**No**, if you select this option, the unit stops recording the partial energy. A display view is not provided and the value displayed by communications is 0.

Para saltar entre las diferentes opciones pulsar la tecla de  con pulsaciones cortas.

To validate the data, long press the  button. The device will return to the main programming screen of the **Partial energy display**.



Short press to access the reactive energy display selection screen.

### 6.7.2. REACTIVE ENERGY DISPLAY

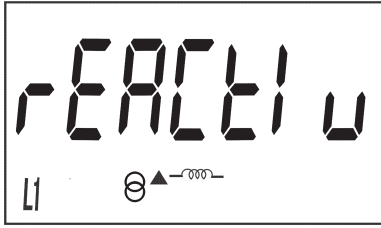

This is the home screen for selecting the reactive energy log display view option.

Long press to view the options.

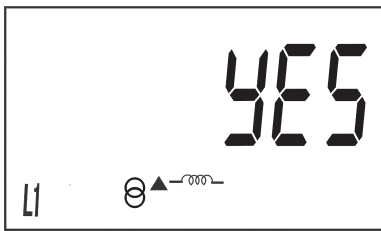

The possible options are:

**Yes**, if you want a display view of the reactive energy screens.

**No**, a display view of the reactive energy screens is not provided, but a communications view is possible.

Short press the  button to browse the different options.

To validate the data, long press the  button. The device will return to the main programming screen of the **Reactive energy display**.

Short press to access the efficiency factors display selection screen:

### 6.7.3. EFFICIENCY FACTORS DISPLAY

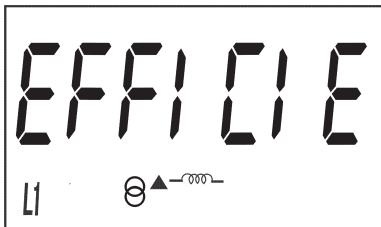

This is the home screen for selecting the display view of the efficiency factors: Cost of energy and CO<sub>2</sub> emissions.

Long press to view the options.

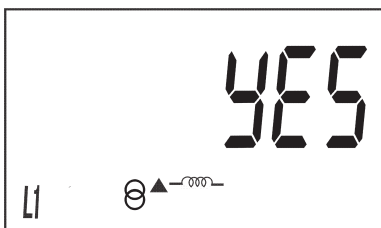

The possible options are:

**Yes**, if you want a display view of the efficiency screens (cost of energy and CO<sub>2</sub> emissions).

**No**, if you select this option, the unit stops recording the efficiency factors. A display view is not provided and the value displayed by communications is 0.

Short press the  button to browse the different options.

To validate the data, long press the  button. The device will return to the main programming screen of the **Efficiency factors display**.

Short press to access the display menu output screen:

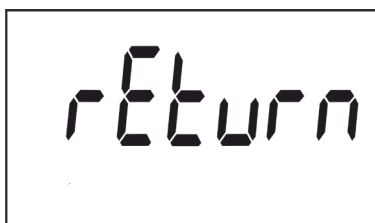

When this screen is displayed:

Short press the  button to return to the first configuration point of the display ( “ 6.7.1. PARTIAL ENERGY DISPLAY”)

Long press the  button to jump to the next programming point.

## 6.8.- BACKLIGHT



This is the home screen for selecting the backlight operating mode of the screen in those units that feature it.

Long press to view the different options:

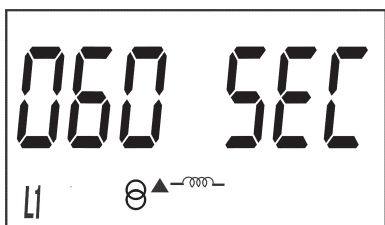



This screen shows the different options:

**ON** : Backlight always ON.

**OFF** : Backlight always OFF.

**005 SEC ... 120 SEC**: ON time after the last press of the buttons.

Short press the  button to browse the different options.

To validate the data, long press the  button and the validation screen will appear (**Figure 16**) indicating that the programming value has been saved.

After a few seconds viewing the screen shown in **Figure 16**, it returns to the main programming screen of the **Backlight**.

Short press the  button to access the next programming step.

## 6.9.- ENERGY COST

**Note:** It is only displayed if the efficiency factors display has been selected.



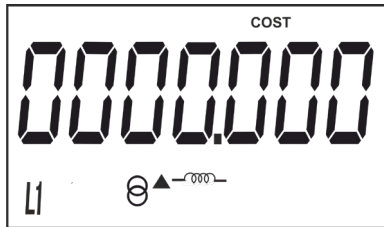

This is the home screen for entering the energy cost per kWh.

Long press the button to view the value to be programmed.



To write or modify the value, short press the  button repeatedly, increasing the value of the flashing digit.

When the desired value is shown on the screen, move onto the next digit with a long press on the  button, allowing the remaining values to be modified.

To validate the data, move to the last digit and long press the  button; the validation screen will appear (**Figure 16**) indicating that the programming value has been saved.

After a few seconds viewing the screen shown on **Figure 16**, the system returns to the **Energy cost** programming main screen.

**Minimum value:** 0.000

**Maximum value:** 9999.999

Short press the  button to access the next programming step.

## 6.10.- CO<sub>2</sub> EMISSIONS

**Note:** It is only displayed if the efficiency factors display has been selected.





This is the home screen for entering the ratio of the carbon emissions.

The carbon emissions ratio is the amount of emissions released into the atmosphere to produce a unit of electricity (1 kWh).

The European mix ratio is approximately 0.65 kgCO<sub>2</sub> per kWh.

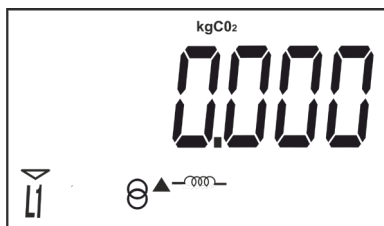
Long press the button to view the value to be programmed.



To write or modify the value, short press the  button repeatedly, increasing the value of the flashing digit.

When the desired value is shown on the screen, move onto the next digit with a long press on the  button, allowing the remaining values to be modified.

To validate the data, move to the last digit and long press the  button; the validation screen will appear (**Figure 16**) indicating that the programming value has been saved.

After a few seconds viewing the screen shown on **Figure 16**, the system returns to the **CO<sub>2</sub> emissions** programming main screen.

**Minimum value:** 0.000

**Maximum value:** 9.000

Short press the  button to access the next programming step.

### 6.11.- PARTIAL ENERGY METER DELETION

**Note:** *It is only displayed if the partial energy display has been selected.*



On this screen you select whether or not to delete the partial energy meters.

Long press the  button to delete the energy meters. The validation screen (**Figure 16**) will be displayed next, indicating that the energy meters were deleted correctly.

After a few seconds viewing the screen shown on **Figure 16**, the system returns to the **Partial energy meter deletion** programming main screen.

### 6.12.- EXITING THE SETUP MENU

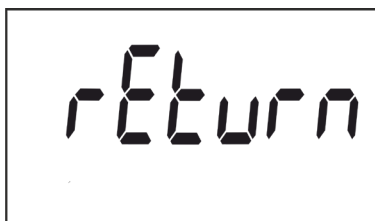

When this screen is displayed:

Long press the  button to exit the setup menu.

Short press the  button to return to the first setup point.

## 7.- COMMUNICATIONS

### 7.1.- INFRARED COMMUNICATIONS PORT (Model **CEM-C21-T1**)

The **CEM-C21-T1** model, in all versions, has a serial optical communications port, in compliance with the UNE EN 62056-21:2003 Standard.

### 7.2.- RS-485 COMMUNICATIONS PORT (Models **CEM-C21-485-xx**)

The **CEM-C21-485-T1** and **CEM-C21-485-DS** models has an RS-485 communication port, with **MODBUS RTU**® protocol.

#### 7.2.1.- CONNECTION

The RS-485 cable must be made up of a twisted pair cable with a braided shield with a maximum distance of 1,200 metres between the **CEM-C21-485-xx** and the master device. A maximum of 32 devices can be connected to this bus.

Use an intelligent RS-232 to RS-485 network protocol converter to establish communications with the master device.

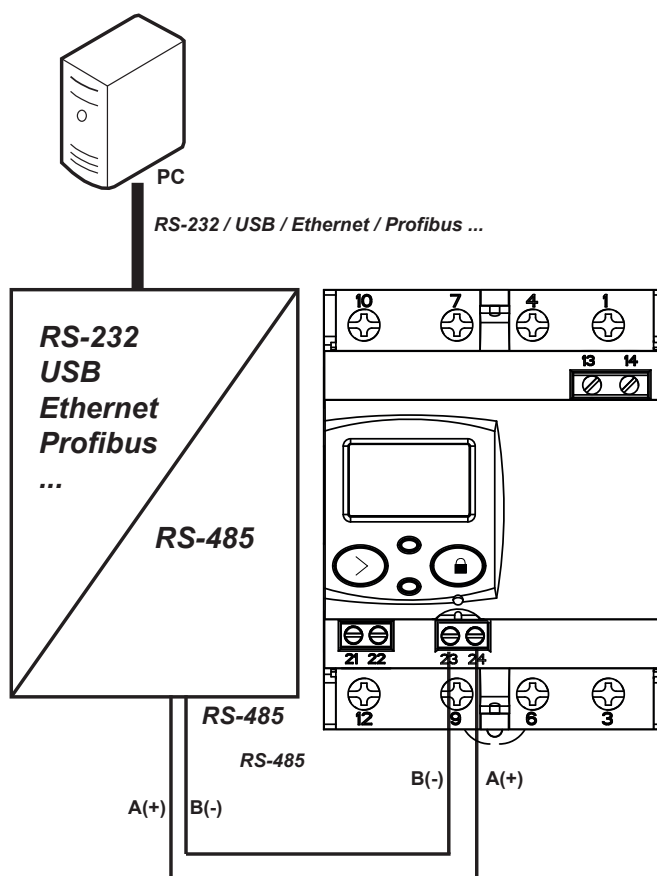

Figure 17: CEM-C21-485-T1 and CEM-C21-485-DS connection diagram.

## 7.2.2.- MODBUS PROTOCOL

The **MODBUS** protocol is a communication standard in the industry that enables the network connection of multiple devices, where there is a master and multiple slaves. Within the **MODBUS** protocol the **CEM-C21-485-xx** uses the RTU (Remote Terminal Unit) mode.

In RTU mode, message starts and ends are detected with silences of at least 3.5 characters, and the 16-bit CRC error-detection method is used.

The **MODBUS** functions implemented in the device are:

**Functions 03** and **04**. Reading registers.

**Function 10**. Writing multiple registers.

### 7.2.2.1.- Read commands

The **CEM-C21-485-xx** supports integer type read functions: 0x03 and 0x04.

*Example: Reading of the device's serial number with peripheral number 01.*

We will send the following Modbus frame:

Address	Function	Initial register	Register no.	CRC
01	04	2710	0002	CRC

The device will respond to us with the next frame:

Address	Function	No. of bytes	Serial no.	CRC
01	04	04	XXXX XXXX	CRC

**Note:** The values are shown in hexadecimal.

The number of requested registers must be the same as the size of the variable requested. It is possible to read several consecutive addresses, if the request meets the correct format.

### 7.2.2.2.- Write commands

The **CEM-C21-485-xx** supports integer type write Functions: 0x10.

*Example: Changing the Modbus address of peripheral 01 to the address 0x000A.*

We will send the following Modbus frame:

Address	Function	Initial register	Register no.	No. bytes	Data	CRC
01	10	03E8	0001	02	000A	CRC

The device will respond to us with the next frame:

Address	Function	Initial Register	Register no.	CRC
01	10	03E8	0001	CRC

**Note:** The values are shown in hexadecimal.

The number of registers to write must be the same as the size of the variable that is being accessed.

It is possible to write several consecutive addresses, if the request meets the correct format.

### 7.2.3.- VARIABLES MODBUS

All **MODBUS** map addresses are hexadecimal.

#### 7.2.3.1.- Energy

The **Read** function is implemented for these variables.

Table 16: Modbus variables: Energy (Table 1).

Description	Address	Size	Units
<b>Total values</b>			
Imported active energy	0x0000	32 bits	Wh
Exported active energy	0x0002	32 bits	Wh
Q1 reactive energy	0x0004	32 bits	varh
Q2 reactive energy	0x0006	32 bits	varh
Q3 reactive energy	0x0008	32 bits	varh
Q4 reactive energy	0x000A	32 bits	varh
<b>Partial values</b>			
Partial imported active energy	0x0030	32 bits	Wh
Partial exported active energy	0x0032	32 bits	Wh
Q1 partial reactive energy	0x0034	32 bits	varh
Q2 partial reactive energy	0x0036	32 bits	varh
Q3 partial reactive energy	0x0038	32 bits	varh
Q4 partial reactive energy	0x003A	32 bits	varh

Table 17 shows energies per tariff, only visible for the **CEM-C21-485-DS** model with the Tariff option selected. (See “6.3.- **DIGITAL INPUT TYPE**”).

Table 17: Modbus variables: Energy (Table 2).

Description	Address		Size	Units
	Tariff 1	Tariff 2		
<b>Total values</b>				
Imported active energy	0x0100	0x010C	32 bits	Wh
Exported active energy	0x0102	0x010E	32 bits	Wh
Q1 reactive energy	0x0104	0x0110	32 bits	varh
Q2 reactive energy	0x0106	0x0112	32 bits	varh
Q3 reactive energy	0x0108	0x0114	32 bits	varh
Q4 reactive energy	0x010A	0x0116	32 bits	varh

Table 17 (Continuation): Modbus variables: Energy (Table 2).

Description	Address		Size	Units
	Tariff 1	Tariff 2		
<b>Partial values</b>				
Partial imported active energy	0x0120	0x012C	32 bits	Wh
Partial exported active energy	0x0122	0x012E	32 bits	Wh
Q1 partial reactive energy	0x0124	0x0130	32 bits	varh
Q2 partial reactive energy	0x0126	0x0132	32 bits	varh
Q3 partial reactive energy	0x0128	0x0134	32 bits	varh
Q4 partial reactive energy	0x012A	0x0136	32 bits	varh

### 7.2.3.2.- Partial energy reset

The **0x05** function is implemented for this variable.

Table 18: Modbus variables: Energy

Description	Address	Activation
Partial energy reset	0x0800	0xFF00

### 7.2.3.3.- Instantaneous values

The **Read** function is implemented for these variables.

Table 19: Modbus variables: Instantaneous values.

Description	Address	Size	Units
Phase 1 voltage	0x0732	32 bits	V (1 primary decimal place)
Phase 2 voltage	0x0734	32 bits	V (1 primary decimal place)
Phase 3 voltage	0x0736	32 bits	V (1 primary decimal place)
Phase 1 current	0x0738	32 bits	A (2 primary decimal places)
Phase 2 current	0x073A	32 bits	A (2 primary decimal places)
Phase 3 current	0x073C	32 bits	A (2 primary decimal places)
Phase 1 cos $\varphi$	0x073E	32 bits	2 decimal places
Phase 2 cos $\varphi$	0x0740	32 bits	2 decimal places
Phase 3 cos $\varphi$	0x0742	32 bits	2 decimal places
Phase 1 active power	0x0746	32 bits	W
Phase 2 active power	0x0748	32 bits	W
Phase 3 active power	0x074A	32 bits	W
Total active power	0x074C	32 bits	W
Phase 1 reactive power	0x074E	32 bits	var
Phase 2 reactive power	0x0750	32 bits	var
Phase 3 reactive power	0x0752	32 bits	var
Total reactive power	0x0754	32 bits	var
Phase 1 apparent power	0x0756	32 bits	VA
Phase 2 apparent power	0x0758	32 bits	VA
Phase 3 apparent power	0x075A	32 bits	VA
Total apparent power	0x075C	32 bits	VA



### 7.2.3.4.- Digital input (CEM-C21-485-DS)

The **Read** function is implemented for these variables.

Table 20: Modbus variables: Digital input

Description	Address	Size
Digital Input status	0x0020	16 bits
Total impulse count	0x0180	32 bits
Partial impulse count	0x0182	32 bits

### 7.2.3.5.- Operating time, cost and KgCO<sub>2</sub> atmospheric emissions

The **Read** function is implemented for these variables.

Table 21: Modbus variables: Operating time, costs and KgCO<sub>2</sub>

Description	Address	Size	Units
Cost of the partial consumption	0x00C0	32 bits	-
KgCO <sub>2</sub> atmospheric emissions of the partial consumption	0x00C2	32 bits	-
Hours of partial operation in seconds	0x00C4	32 bits	-
Hours of total operation in seconds	0x00C6	32 bits	-

### 7.2.3.6.- Other parameters

The **Read** function is implemented for these variables.

Table 22: Modbus variables: Other parameters.

Description	Address	Size	Units
Energy meter model <sup>(16)</sup>	0xF010	6x16 bits	12 bytes in ASCII format
Serial no	0x0060	32 bits	-
Identifier ID no.	0x0068	32 bits	-
Energy meter firmware version			
Higher firmware version	0x0050	16 bits	-
Lower firmware version	0x0051	16 bits	-
Revised firmware version	0x0052	16 bits	-

<sup>(16)</sup> Energy meter model description table, **Table 23**.

Table 23: Energy meter model description table.

Options	Description	bytes in ASCII format
<b>Connection mode</b>	4 wires	4
<b>Accuracy</b>	Class B active / Does not measure reactive energy	10
	Class B active / Class 2.0 reactive	12
<b>Measurement voltage</b>	3x127/220 ... 3x230/400 V	U
	3x127/220 V	N
	3x230/400 V	Q
<b>Current measurement</b>	Direct 10(60)A	D4
	Direct 5(65)A	D7
<b>Frequency</b>	50Hz	A
	60 Hz	B
	Automatic (50/60Hz)	C

Table 23 (Continuation): Energy meter model description table.

Opciones		bytes en formato ASCII
<b>Communications</b>	Without communications	0
	Side optical service port	1
<b>Expansion</b>	Without inputs/outputs	0
	Input/Output (Optocoupler)	1
<b>Model</b>	Box for assembly on DIN rail	E
<b>Number of quadrants</b>	2 quadrants	0
	4 quadrants	1
	Storage in both directions	2
<b>Additional features</b>	No special features	0

### 7.2.3.7.- Configuration variables

The **Read** and **Write** functions are implemented for these variables.

Table 24: Modbus configuration variables CEM-C21-485-xx.

Description	Address	Size	Valid data range	Default value
Impulse output weight	0x0081	16 bits	Wh/impulse 0 ... 99999	-
Impulse output type	0x0080	16 bits	<b>0:</b> Active energy, <b>1:</b> Reactive energy	0
Digital input type	0x0454	16 bits	<b>0:</b> Tariff, <b>1:</b> impulse counter	0
Modbus address	0x03E8	16 bits	1 ... 254	1
Transmission speed (Baudrate)	0x03E9	16 bits	<b>0:</b> 9600, <b>1:</b> 19200, <b>2:</b> 38400	<b>0:</b> 9600
Communications configuration	0x03EA	16 bits	<b>0:</b> 8N1 ( 8 bits - No parity -1 stop bit) <b>1:</b> 8E1 ( 8 bits - Even parity -1 stop bit) <b>2:</b> 8O1 ( 8 bits - Odd parity -1 stop bit) <b>3:</b> 8N2 ( 8 bits - No parity -2 stop bit) <b>4:</b> 8E2 ( 8 bits - Even parity -2 stop bit) <b>5:</b> 8O2 ( 8 bits - Odd parity -2 stop bit)	0
Display visualisation	0x00B4	16 bits	The variable format is displayed in <b>Table 25</b>	-
Backlight	0x00B5	16 bits	0 ... 120	60 s
Cost per kWh	0x00B0	32 bits	0.0000 ... 9999.9999 with 4 decimal places of resolution	-
KgCO <sub>2</sub>	0x00B2	32 bits	0.0000 ... 9.0000 with 4 decimal places of resolution	-

Table 25: Variable format Display Visualisation.

Bit 4	Bit 3	Bit 2	Bit 1	Bit 0
<b>1:</b> Impulse	<b>1:</b> Tariffs	<b>1:</b> Efficiency factors	<b>1:</b> Reactive Energy	<b>1:</b> Partial Energies

## 8.- TECHNICAL FEATURES

Power supply		
Mode	Auxiliary	
Rated voltage	CEM-C21-T1-MID CEM-C21-485-T1-MID CEM-C21-485-DS-MID	CEM-C21-T1 CEM-C21-485-T1 CEM-C21-485-DS
	230 V ~	230 V ~ / 400 V ~ <sup>(17)</sup>
Tolerance	± 20 %	
Frequency	50...60Hz	
Consumption	< 2 W < 10VA (In, Vref (without auxiliary services))	

Voltage Measurement	
Connection	Three-phase
Reference voltages <sup>(17)</sup>	3x127/220 ... 3x230/400 V ~, 3x127/220 V~ or 3x230/400 V ~
Frequency <sup>(17)</sup>	50 Hz, 60 Hz or 50/60 Hz
Self-consumption of the voltage circuit	< 2 W < 10VA (In, Vref (without auxiliary services))

<sup>(17)</sup> according to version.

Current measurement		
Current (Ib / Iref)	5 A	
Maximum current (Imax)	65 A	
Start-up current	0.04% of Itr	
Self-consumption of the current circuit	0.3 VA @ 10 A	
Itr	0.500 A	
Ist	0.020 A	
Imin	0.250 A	
Maximum overcurrent time ( 30xImax) ( according to EN-50470-3)	50Hz	60Hz
	½ cycle	½ cycle

Accuracy		
Active Energy	CEM-C21-T1-MID CEM-C21-485-T1-MID CEM-C21-485-DS-MID	CEM-C21-T1 CEM-C21-485-T1 CEM-C21-485-DS
	Class B (EN 50470)	Class 1 (IEC 62053-21)
Reactive Energy	Class 2.0 (IEC 62053-23)	

Insulation	
AC voltage	4kV RMS 50Hz during 1 minute

Overimpulse	
1.2/50ms 0R source impedance	6 kV at 60° and 240°, with positive and negative polarization

Calculation and processing	
Microprocessor	ARM
AD converter	16-bit

Impulse output (Models CEM-C21-T1 and CEM-C21-485-T1)	
Type	Optocoupler
Operation	Emission of impulses proportional to the energy
Electrical features	Max. 24V <sub>DC</sub> 50mA

<b>(Continuation) Impulse output (Models CEM-C21-T1 and CEM-C21-485-T1)</b>		
Impulse ON time	<b>CEM-C21-T1-MID CEM-C21-485-T1-MID</b>	<b>CEM-C21-T1 CEM-C21-485-T1</b>
	40 ms	200 ms
No. of maximum impulses per second	12	
<b>Digital input (Model CEM-C21-485-DS)</b>		
Type	Self-powered a +5V --- (Vmax: 5.1V, Imax: 8.5 mA)	
Operation	Tariff selection	
Maximum impedance	800 Ω	
Pulse width	Ton ≥ 30 ms, Toff ≥ 30 ms	
<b>IR port (service port) (Model CEM-C21-T1)</b>		
Hardware	EN62056-21	
Communications protocol	Modbus	
Baud rate	9600	
Data bits	8	
Stop bits	1	
Parity	no parity	
<b>RS-485 Communications (Models CEM-C21-485-T1 and CEM-C21-485-DS)</b>		
Hardware	RS-485	
Protocol	Modbus	
Baud rate	9600, 19200, 38400 bps	
Data bits	8	
Stop bits	1	
Parity	without -even - odd	
<b>User interface</b>		
Display	LCD	
Maximum counter value	999999.9 kWh	
Buttons	2 buttons	
LED	2 LEDs: kWh, 4000 imp/kWh kvarh, 4000 imp/kvarh	
<b>Environmental features</b>		
Operating temperature	-25°C... +70°C	
Storage temperature	-35°C... +80°C	
Relative humidity (non-condensing)	5 ... 95%	
Maximum altitude	2,000 m	
<b>Mechanical features</b>		
Dimensions (Figure 18) in mm.	IEC60715	
Weight	<b>CEM-C21-T1</b>	<b>CEM-C21-485-T1 CEM-C21-485-DS</b>
	340 g.	341 g.
Enclosure	EN50022	
Protection degree	IP 51 installed IP40 in terminal area	
<b>Standards</b>		
Electrical energy metering equipment (AC). Part 1: General requirements, tests and test conditions. Metering equipment (indexes of classes A, B and C)	UNE EN 50470-1	

(Continuation) Standards	
Electrical energy metering equipment (AC). Part 3: Particular requirements. Static active energy meters (classification indexes A, B and C).	UNE EN 50470-3
Electrical energy metering equipment (AC). Particular requirements. Part 21: Static active energy meters (classes 1 and 2)	IEC 62053-21
Electrical energy metering equipment (AC). Particular requirements. Part 23: Static reactive energy meters (classes 2 and 3).	IEC 62053-23

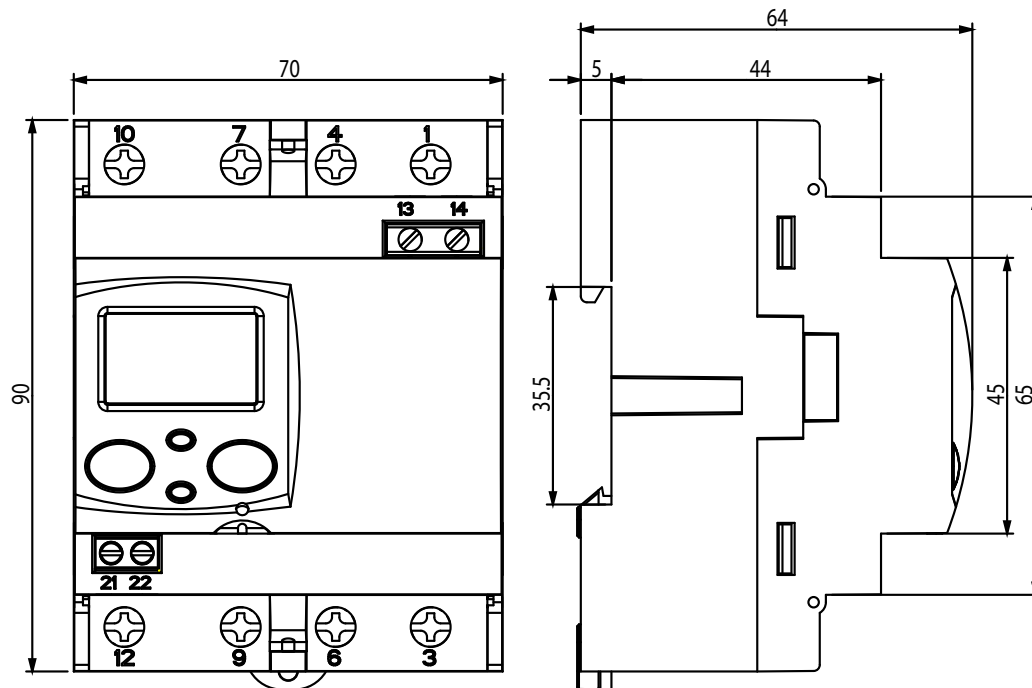

Figure 18: Dimensions of the CEM-C21.

## 9.- MAINTENANCE AND TECHNICAL SERVICE

In the case of any query in relation to device operation or malfunction, please contact the **CIRCUTOR, SA** Technical Support Service.

### Technical Assistance Service

Vial Sant Jordi, s/n, 08232 - Viladecavalls (Barcelona)

Tel: 902 449 459 ( España ) / +34 937 452 919 (outside of Spain)

email: sat@circutor.com

## 10.- GUARANTEE

**CIRCUTOR** guarantees its products against any manufacturing defect for two years after the delivery of the units.

**CIRCUTOR** will repair or replace any defective factory product returned during the guarantee period.



- No returns will be accepted and no unit will be repaired or replaced if it is not accompanied by a report indicating the defect detected or the reason for the return.
- The guarantee will be void if the units has been improperly used or the storage, installation and maintenance instructions listed in this manual have not been followed. "Improper usage" is defined as any operating or storage condition contrary to the national electrical code or that surpasses the limits indicated in the technical and environmental features of this manual.
- **CIRCUTOR** accepts no liability due to the possible damage to the unit or other parts of the installation, nor will it cover any possible sanctions derived from a possible failure, improper installation or "improper usage" of the unit. Consequently, this guarantee does not apply to failures occurring in the following cases:
  - Overvoltages and/or electrical disturbances in the supply;
  - Water, if the product does not have the appropriate IP classification;
  - Poor ventilation and/or excessive temperatures;
  - Improper installation and/or lack of maintenance;
  - Buyer repairs or modifications without the manufacturer's authorisation.

**11.- CE CERTIFICATE**

**CIRCUITOR, SA** – Vial Sant Jordi, s/n  
08232 Viladecavalls (Barcelona) Spain  
(+34) 937 452 900 – info@circuitor.com

**DECLARACIÓN UE DE CONFORMIDAD**

La presente declaración de conformidad se expide bajo la exclusiva responsabilidad de CIRCUITOR con dirección en Vial Sant Jordi, s/n – 08232 Viladecavalls (Barcelona) España

Producto:

Contadores de energía trifásicos directo con comunicaciones

Serie:

CEM-C21

Marca:

**CIRCUITOR**

EL objeto de la declaración es conforme con la legislación de armonización pertinente en la UE, siempre que sea instalado, mantenido y usado en la aplicación para la que ha sido fabricado, de acuerdo con las normas de instalación aplicables y las instrucciones del fabricante  
2014/35/UE: Low Voltage Directive 2014/30/UE: EMC Directive 2011/65/UE: RoHS2 Directive 2015/863/UE: RoHS3 Directive

Está en conformidad con la(s) siguiente(s) norma(s) u otro(s) documento(s) normativos(s):

IEC 62053-21:2003 Ed 1.0 IEC 62053-23:2003 Ed 1.0

Año de marcado "CE":

2018

**EU DECLARATION OF CONFORMITY**

This declaration of conformity is issued under the sole responsibility of CIRCUITOR with registered address at Vial Sant Jordi, s/n – 08232 Viladecavalls (Barcelona) Spain

Product:

Direct three-phase energy meters with communications module

Series:

CEM-C21

Brand:

**CIRCUITOR**

The object of the declaration is in conformity with the relevant EU harmonisation legislation, provided that it is installed, maintained and used for the application for which it was manufactured, in accordance with the applicable installation standards and the manufacturer's instructions  
2014/35/UE: Low Voltage Directive 2014/30/UE: EMC Directive 2011/65/UE: RoHS2 Directive 2015/863/UE: RoHS3 Directive

It is in conformity with the following standard(s) or other regulatory document(s):

IEC 62053-21:2003 Ed 1.0 IEC 62053-23:2003 Ed 1.0

Year of CE mark:

2018

Viladecavalls (Spain), 11/2/2020  
General Manager: Ferran Gil Torné

**DECLARATION UE DE CONFORMITÉ**

La présente déclaration de conformité est délivrée sous la responsabilité exclusive de CIRCUITOR dont l'adresse postale est Vial Sant Jordi, s/n – 08232 Viladecavalls (Barcelone) Espagne

Produit:

mesureurs d'énergie triphasés connexion directes avec module communication

Série:

CEM-C21

Marque:

**CIRCUITOR**

L'objet de la déclaration est conforme à la législation d'harmonisation pertinente dans l'UE, à condition d'avoir été installé, entretenu et utilisé dans l'application pour laquelle il a été fabriqué, conformément aux normes d'installation applicables et aux instructions du fabricant  
2014/35/UE: Low Voltage Directive 2014/30/UE: EMC Directive 2011/65/UE: RoHS2 Directive 2015/863/UE: RoHS3 Directive

Il est en conformité avec la(les) suivante (s) norme(s) ou autre(s) document(s) réglementaire (s):

IEC 62053-21:2003 Ed 1.0 IEC 62053-23:2003 Ed 1.0

Année de marquage « CE »:

2018





**CIRCUITOR, SA** – Vial Sant Jordi, s/n  
08232 Viladecavalls (Barcelona) Spain  
(+34) 937 452 900 – info@circuitor.com



**KONFORMITÄTSERKÄRUNG UE**

Vorliegende Konformitätserklärung wird unter alleiniger Verantwortung von CIRCUITOR mit der Anschrift, Vial Sant Jordi, s/n – 08232 Viladecavalls (Barcelona) Spanien, ausgestellt

Produkt:

**Dreiphasen-Energiezähler direkter Anschluss und Kommunikationsmodule**

Serie:

**CEM-C21**

Marke:

**CIRCUITOR**

Der Gegenstand der Konformitätserklärung ist konform mit der geltenden Gesetzgebung zur Harmonisierung der EU, sofern die Installation, Wartung und Verwendung der Anwendung seinem Verwendungszweck entsprechend gemäß den geltenden Installationsstandards und der Vorgaben des Herstellers erfolgt.

2014/35/UE: Low Voltage Directive 2014/30/UE: EMC Directive  
2011/65/UE: RoHS2 Directive 2015/863/UE: RoHS3 Directive

Es besteht Konformität mit der/den folgender/folgenden Norm/Normen oder sonstigem/sonstiger Regelwerk/Regelwerken

IEC 62053-21:2003 Ed 1.0 IEC 62053-23:2003 Ed 1.0

Jahr der CE-Kennzeichnung:  
2018



**DECLARAÇÃO DA UE DE CONFORMIDADE**

A presente declaração de conformidade é expedida sob a exclusiva responsabilidade da CIRCUITOR com morada em Vial Sant Jordi, s/n – 08232 Viladecavalls (Barcelona) Espanha

Produto:

**Contadores de energia trifásicos ligação directa e modulo de comunicação**

Série:

**CEM-C21**

Marca:

**CIRCUITOR**

O objeto da declaração está conforme a legislação de harmonização pertinente na UE, sempre que seja instalado, mantido e utilizado na aplicação para a qual foi fabricado, de acordo com as normas de instalação aplicáveis e as instruções do fabricante.

2014/35/UE: Low Voltage Directive 2014/30/UE: EMC Directive  
2011/65/UE: RoHS2 Directive 2015/863/UE: RoHS3 Directive

Está em conformidade com a(s) seguinte(s) norma(s) ou outro(s) documento(s) normativo(s):

IEC 62053-21:2003 Ed 1.0 IEC 62053-23:2003 Ed 1.0

Ano de marcação "CE":  
2018

Viladecavalls (Spain), 11/2/2020  
General Manager: Ferran Gil Torné



**DICHIARAZIONE DI CONFORMITÀ UE**

La presente dichiarazione di conformità viene rilasciata sotto la responsabilità esclusiva di CIRCUITOR, con sede in Vial Sant Jordi, s/n – 08232 Viladecavalls (Barcelona) Spagna

prodotto:

**Contatori di energia trifase diretto con modulo comunicazioni**

Serie:

**CEM-C21**

MARCHIO:

**CIRCUITOR**

L'oggetto della dichiarazione è conforme alla pertinente normativa di armonizzazione dell'Unione Europea, a condizione che venga installato, mantenuto e utilizzato nell'ambito dell'applicazione per cui è stato prodotto, secondo le norme di installazione applicabili e le istruzioni del produttore.

2014/35/UE: Low Voltage Directive 2014/30/UE: EMC Directive  
2011/65/UE: RoHS2 Directive 2015/863/UE: RoHS3 Directive

È conforme alle seguenti normative o altri documenti normativi:

IEC 62053-21:2003 Ed 1.0 IEC 62053-23:2003 Ed 1.0

Anno di marcatura "CE":  
2018

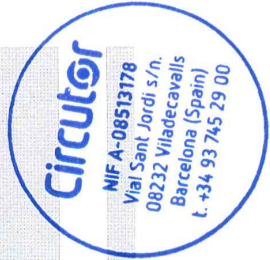



**DEKLARACJA ZGODNOŚCI UE**

Niniejsza deklaracja zgodności zostaje wydana na wyłączną odpowiedzialność firmy CIRCUTOR z siedzibą pod adresem: **Vial Sant Jordi, s/n – 08232 Viladecavalls (Barcelona) Hiszpania**

produkt:

**trójfazowe liczniki energii podłączenie bezpośrednie i Moduły komunikacyjne**

Seria:

**CEM-C21**

marka:

**CIRCUTOR**

Przedmiot deklaracji jest zgodny z odnośnymi wymaganiami prawodawstwa harmonizacyjnego w Unii Europejskiej pod warunkiem, że będzie instalowany, konserwowany i użytkowany zgodnie z przeznaczeniem, dla którego został wyprodukowany, zgodnie z mającymi zastosowanie normami dotyczącymi instalacji oraz instrukcjami producenta

2014/35/UE: Low Voltage Directive    2014/30/UE: EMC Directive  
2011/65/UE: RoHS2 Directive    2015/863/UE: RoHS3 Directive

Jest zgodny z następującą(y) normą(ami) lub innym(i) dokumentem(ami) normatywnym(i):

IEC 62053-21:2003 Ed 1.0    IEC 62053-23:2003 Ed 1.0

Rok oznakowania "CE":

2018



Viladecavalls (Spain), 11/2/2020  
General Manager: Ferran Gil Torné



**DECLARACIÓN UE DE CONFORMIDAD**

La presente declaración de conformidad se expide bajo la exclusiva responsabilidad de CIRCUITOR con dirección en Vial Sant Jordi, s/n – 08232 Viladecavalls (Barcelona) España

Producto:

Contadores de energía trifásicos directo con comunicaciones

Serie:

CEM-C21 MID

Marca:

CIRCUITOR

EL objeto de la declaración es conforme con la legislación de armonización pertinente en la UE, siempre que sea instalado, mantenido y usado en la aplicación para la que ha sido fabricado, de acuerdo con las normas de instalación aplicables y las instrucciones del fabricante

2014/52/CE: Measuring Instrument Directive 2011/65/UE: RoHS2 Directive  
2015/863/UE: RoHS3 Directive

Está en conformidad con la(s) siguiente(s) norma(s) u otro(s) documento(s) normativos(s):

EN 50470-1:2006 EN 550470-3:2006

Año de marcado "CE":

2019



**EU DECLARATION OF CONFORMITY**

This declaration of conformity is issued under the sole responsibility of CIRCUITOR with registered address at Vial Sant Jordi, s/n – 08232 Viladecavalls (Barcelona) Spain

Product:

Direct three-phase energy meters with communications module

Series:

CEM-C21 MID

Brand:

CIRCUITOR

The object of the declaration is in conformity with the relevant EU harmonisation legislation, provided that it is installed, maintained and used for the application for which it was manufactured, in accordance with the applicable installation standards and the manufacturer's instructions

2014/52/CE: Measuring Instrument Directive 2011/65/UE: RoHS2 Directive  
2015/863/UE: RoHS3 Directive

It is in conformity with the following standard(s) or other regulatory document(s):

EN 50470-1:2006 EN 550470-3:2006

Year of CE mark:

2019



**DÉCLARATION UE DE CONFORMITÉ**

La présente déclaration de conformité est délivrée sous la responsabilité exclusive de CIRCUITOR dont l'adresse postale est Vial Sant Jordi, s/n – 08232 Viladecavalls (Barcelona) Espagne

Produit:

mesureurs d'énergie triphasés connexion directes avec module communication

Série:

CEM-C21 MID

Marque:

CIRCUITOR

L'objet de la déclaration est conforme à la législation d'harmonisation pertinente dans l'UE, à condition d'avoir été installé, entretenu et utilisé dans l'application pour laquelle il a été fabriqué, conformément aux normes d'installation applicables et aux instructions du fabricant

2014/52/CE: Measuring Instrument Directive 2011/65/UE: RoHS2 Directive  
2015/863/UE: RoHS3 Directive

Il est en conformité avec la(les) suivante (s) norme(s) ou autre(s) document(s) réglementaire (s):

EN 50470-1:2006 EN 550470-3:2006

Année de marquage « CE »:

2019



Viladecavalls (Spain), 11/2/2020  
General Manager: Ferran Gil Torné

**CIRCUITOR, SA** – Vial Sant Jordi, s/n  
08232 Viladecavalls (Barcelona) Spain  
(+34) 937 452 900 – info@circuitor.com

**KONFORMITÄTSERKLÄRUNG UE**

Vorliegende Konformitätserklärung wird unter alleiniger Verantwortung von CIRCUITOR mit der Anschrift, Vial Sant Jordi, s/n – 08232 Viladecavalls (Barcelona) Spanien, ausgestellt

Produkt:

**Dreiphasen-Energiezähler direkter Anschluss und Kommunikationsmodule**

Série:

**CEM-C21 MID**

Marke:

**CIRCUITOR**

Der Gegenstand der Konformitätserklärung ist konform mit der geltenden Gesetzgebung zur Harmonisierung der EU, sofern die Installation, Wartung und Verwendung der Anwendung seinem Verwendungszweck entsprechend gemäß den geltenden Installationsstandards und der Vorgaben des Herstellers erfolgt.

2014/52/CE: Measuring Instrument Directive 2011/65/UE: RoHS2 Directive  
2015/863/UE: RoHS3 Directive

Es besteht Konformität mit der/den folgender/folgenden Norm/Normen oder sonstigem/sonstiger Regelwerk/Regelwerken

EN 50470-1:2006 EN 550470-3:2006

Jahr der CE-Kennzeichnung:  
2019

**DECLARAÇÃO DA UE DE CONFORMIDADE**

A presente declaração de conformidade é expedida sob a exclusiva responsabilidade da CIRCUITOR com morada em

Vial Sant Jordi, s/n – 08232 Viladecavalls (Barcelona) Espanha

Produto:

**Contadores de energia trifásicos ligação directa e modulo de comunicação**

Série:

**CEM-C21 MID**

Marca:

**CIRCUITOR**

O objeto da declaração está conforme a legislação de harmonização pertinente na UE, sempre que seja instalado, mantido e utilizado na aplicação para a qual foi fabricado, de acordo com as normas de instalação aplicáveis e as instruções do fabricante.

2014/52/CE: Measuring Instrument Directive 2011/65/UE: RoHS2 Directive  
2015/863/UE: RoHS3 Directive

Está em conformidade com a(s) seguinte(s) norma(s) ou outro(s) documento(s) normativo(s):

EN 50470-1:2006 EN 550470-3:2006

Ano de marcação "CE":  
2019

Viladecavalls (Spain), 11/2/2020  
General Manager: Ferran Gil Torné

**DICHIARAZIONE DI CONFORMITÀ UE**

La presente dichiarazione di conformità viene rilasciata sotto la responsabilità esclusiva di CIRCUITOR, con sede in

Vial Sant Jordi, s/n – 08232 Viladecavalls (Barcelona) Spagna

prodotto:

**Contatori di energia trifase diretto con modulo comunicazioni**

Serie:

**CEM-C21 MID**

MARCHIO:

**CIRCUITOR**

L'oggetto della dichiarazione è conforme alla pertinente normativa di armonizzazione dell'Unione Europea, a condizione che venga installato, mantenuto e utilizzato nell'ambito dell'applicazione per cui è stato prodotto, secondo le norme di installazione applicabili e le istruzioni del produttore.

2014/52/CE: Measuring Instrument Directive 2011/65/UE: RoHS2 Directive  
2015/863/UE: RoHS3 Directive

È conforme alle seguenti normative o altri documenti normativi:

EN 50470-1:2006 EN 550470-3:2006

Anno di marcatura "CE":  
2019





**DEKLARACJA ZGODNOŚCI UE**

Niniejsza deklaracja zgodności zostaje wydana na wyłączną odpowiedzialność firmy CIRCUTOR z siedzibą pod adresem: Vial Sant Jordi, s/n – 08232 Viladecavalls (Barcelona) Hiszpania

produkt:

**trójfazowe liczniki energii podłączenie bezpośrednie i Moduły komunikacyjne**

Seria:

**CEM-C21 MID**

marka:

**CIRCUTOR**

Przedmiot deklaracji jest zgodny z odnośnymi wymaganiami prawodawstwa harmonizacyjnego w Unii Europejskiej pod warunkiem, że będzie instalowany, konserwowany i użytkowany zgodnie z przeznaczeniem, dla którego został wyprodukowany, zgodnie z mającymi zastosowanie normami dotyczącymi instalacji oraz instrukcjami producenta

2014/52/UE: Measuring Instrument Directive 2011/65/UE: RoHS2 Directive  
2015/863/UE: RoHS3 Directive

Jest zgodny z następującą(y)mi normą(ami) lub innym(i) dokumentem(ami) normatywnym(i):

**E N 5 0 4 7 0 - 1 : 2 0 0 6 E N 5 5 0 4 7 0 - 3 : 2 0 0 6**

Rok oznakowania "CE":

**2019**

Viladecavalls (Spain) 11/2/2020  
General Manager: Ferran Gil Torné





**CIRCUTOR, SA**

Vial Sant Jordi, s/n

08232 - Viladecavalls (Barcelona)

Tel.: (+34) 93 745 29 00 - Fax: (+34) 93 745 29 14

[www.circutor.com](http://www.circutor.com) [central@circutor.com](mailto:central@circutor.com)